

Product data sheet

Characteristics

TM5SE1IC01024

Counter module, Modicon TM5, 1 HSC incremental, 100 KHz



Product availability: Non-Stock - Not normally stocked in distribution facility

Price*: 380.00 USD



Main

Range of Product	Modicon TM5
Product or Component Type	Counter module
Product Specific Application	Downcounting Frequency generator Upcounting Period measurement Frequency meter Axis following with encoder
Function of module	2 x 24 V DC auxiliary inputs 24 V DC encoder power supply
Discrete input number	1
Counting frequency	100 KHz
Encoder type	1 incremental encoder

Complementary

Range Compatibility	Modicon LMC058 Modicon M258
Product Compatibility	Logic controller Motion controller
Counter inputs resolution	16 bits/32 bits
Maximum cycle time	2 Ms
Input compatibility	1 incremental encoder (24 V)
Isolation	500 Vrms AC insulation between channel and bus
Discrete input logic	Sink
Discrete input voltage	24 V DC
Discrete input current	3.3 MA 24 V
Input resistance	7.19 KOhm
Current consumption	2 mA at 5 V DC bus 58 mA 24 V DC input/output
Maximum power dissipation in W	1.41 W
Marking	CE
Net Weight	0.06 Lb(US) (0.025 kg)

Environment

Standards	IEC 61131-2 CSA C22.2 No 213 CSA C22.2 No 142 UL 508
Product Certifications	CSA C-tick GOST-R CULus
Ambient air temperature for operation	32...131 °F (0...55 °C) without derating horizontal installation) 32...140 °F (0...60 °C) with derating factor horizontal installation) 32...122 °F (0...50 °C) vertical installation)
Ambient Air Temperature for Storage	-13...158 °F (-25...70 °C)
Relative humidity	5...95 % without condensation
IP degree of protection	IP20IEC 61131-2
Pollution degree	2 IEC 60664
Operating altitude	0...6561.68 ft (0...2000 m)
Storage altitude	0.00...9842.52 Ft (0...3000 m)
Vibration resistance	1 gn 8.4...150 Hz DIN rail 3.5 mm 5...8.4 Hz DIN rail
Shock resistance	15 gn 11 ms
Resistance to electrostatic discharge	4 KV on contact EN/IEC 61000-4-2 8 KV in air EN/IEC 61000-4-2
Resistance to electromagnetic fields	0.91 V/M (1 V/m) 2...2.7 GHz EN/IEC 61000-4-3 9.14 V/M (10 V/m) 80...2000 MHz EN/IEC 61000-4-3
Resistance to fast transients	1 KV EN/IEC 61000-4-4 I/O) 1 KV EN/IEC 61000-4-4 shielded cable) 2 KV EN/IEC 61000-4-4 power lines)
Surge withstand	0.5 KV differential mode EN/IEC 61000-4-5 1 KV common mode EN/IEC 61000-4-5
Electromagnetic compatibility	EN/IEC 61000-4-6
Disturbance radiated/conducted	CISPR 11

Ordering and shipping details

Category	22532 - M258 PLC
Discount Schedule	PC12
GTIN	03595864074849
Nbr. of units in pkg.	1
Package weight(Lbs)	1.34 Oz (38 g)
Returnability	No
Country of origin	AT

Packing Units

Unit Type of Package 1	PCE
Package 1 Height	0.75 In (1.9 cm)
Package 1 width	2.32 In (5.9 cm)
Package 1 Length	4.09 In (10.4 cm)

Offer Sustainability

Sustainable offer status	Green Premium product
California proposition 65	WARNING: This product can expose you to chemicals including: Lead and lead compounds, which is known to the State of California to cause cancer and birth defects or other reproductive harm. For more information go to www.P65Warnings.ca.gov
REACH Regulation	REACH Declaration
REACH free of SVHC	Yes
EU RoHS Directive	Pro-active compliance (Product out of EU RoHS legal scope) EU RoHS Declaration
Toxic heavy metal free	Yes
Mercury free	Yes
RoHS exemption information	Yes
China RoHS Regulation	China RoHS Declaration
Environmental Disclosure	Product Environmental Profile
Circularity Profile	End Of Life Information
WEEE	The product must be disposed on European Union legal markets following specific waste collection and never end up in rubbish bins.
PVC free	Yes

Contractual warranty

Warranty	18 months
----------	-----------

TM5 Slice

Dimensions



TM5 System

Spacing Requirements

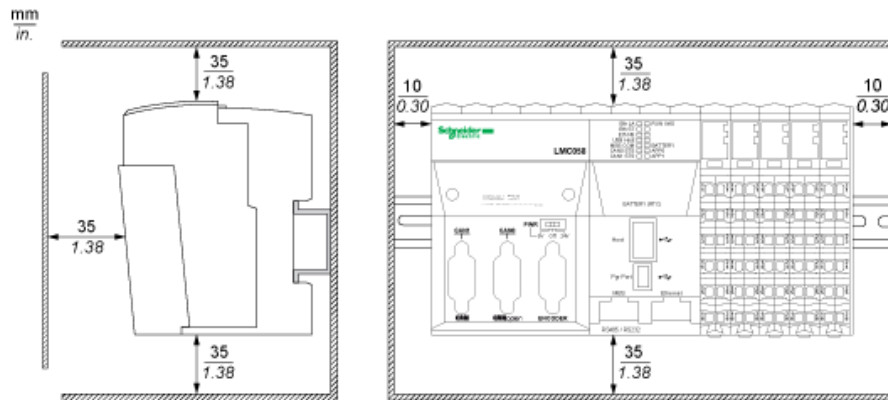



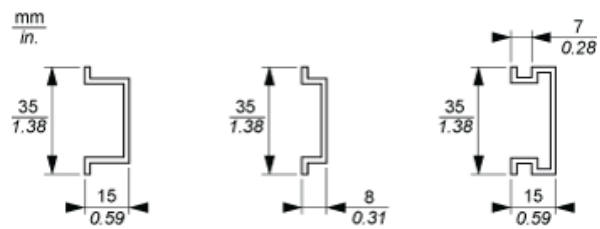

Mounting on a DIN Rail



TM5 System Wiring Recommendations

Wire Sizes to Use with the Removable Spring Terminal Blocks

mm in.				
mm ²	0,08...2,5	0,25...2,5	0,25...1,5	2 x 0,25...2 x 0,75
AWG	28...14	24...14	24...16	2 x 24...2 x 18

Electronic Module 1 HSC INC 100 KHz

Wiring Diagram

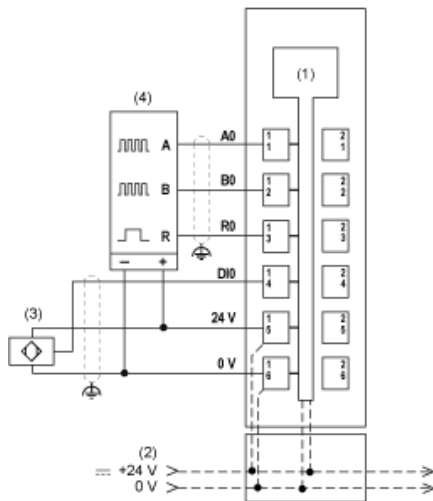

- (1) Internal electronics
- (2) 24 Vdc I/O power segment integrated into bus base
- (3) 3-wire sensor
- (4) Encoder

Product Life Status : **Commercialised**